

KKR-1/2"x5/16"-Z13

Typ	Di +0,2	Da
50x1,5.40	47,3	49,9

Weitere Varianten auf Anfrage!

☛ Radkörper: Kunststoff

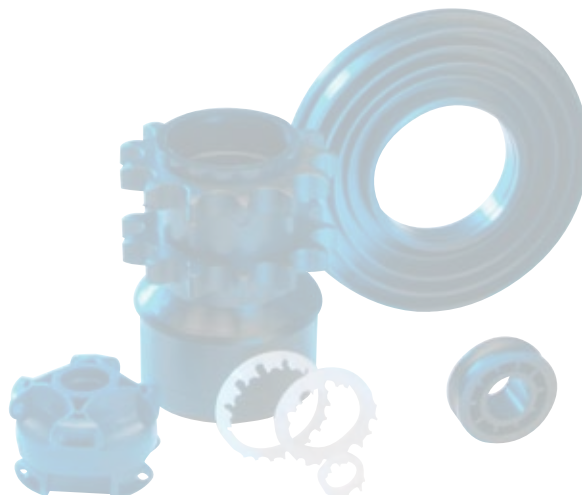

KKR-40

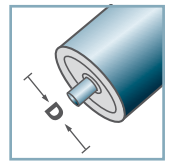

D [mm]
50

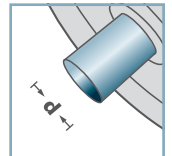

d [mm]
-



C [daN]
-

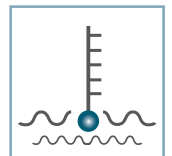

T [°C]
0° - 80°



-



Karton [Stck.]

150

Kunststoffkettenrad

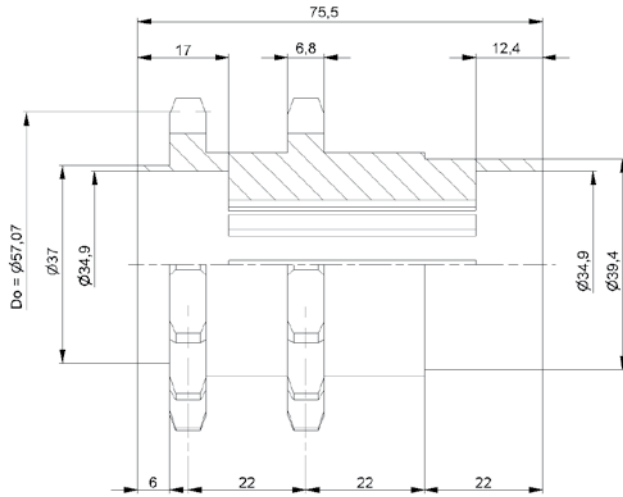

KKR-1/2"x5/16"-Z14

Weitere Varianten auf Anfrage!

Radkörper: Kunststoff

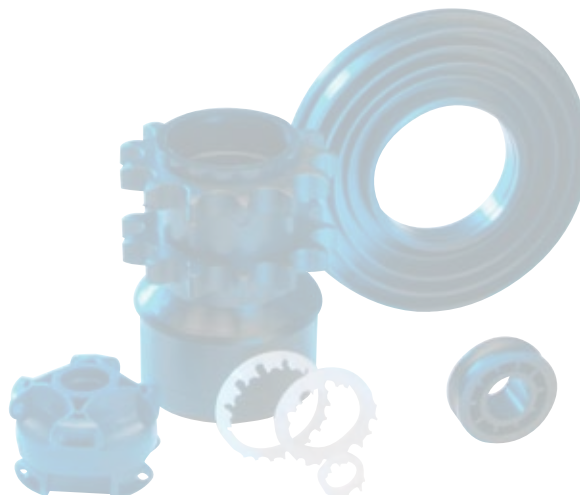

KKR-40

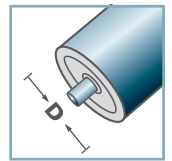

D [mm]

-

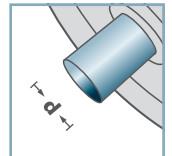

d [mm]

-



C [daN]

-

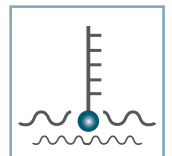

T [°C]

0° - 80°



-



Karton [Stck.]

100

Kunststoffkettenrad

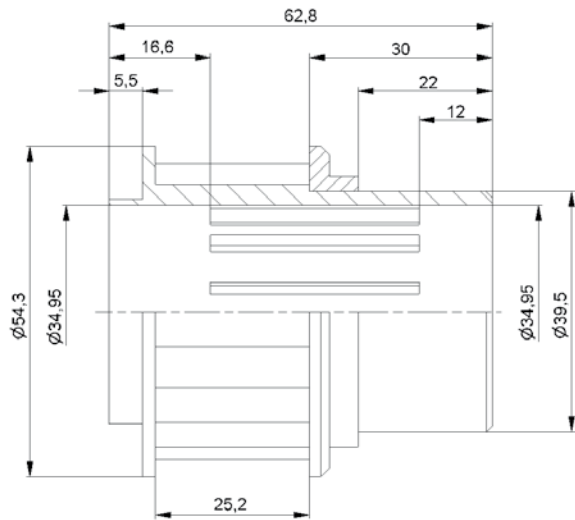

KZA-Z20.40

Weitere Varianten auf Anfrage!

☞ Radkörper: Kunststoff

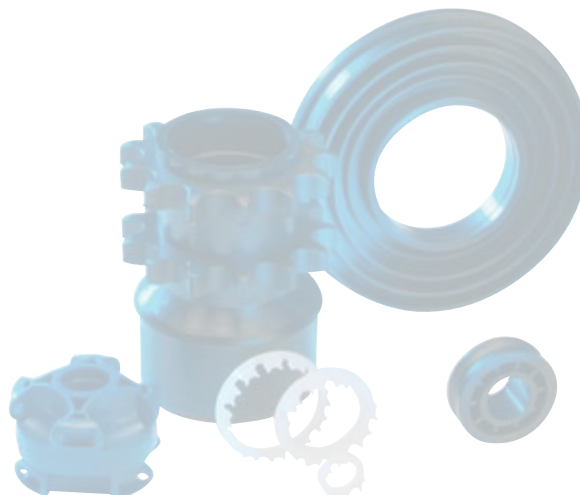

KZA-40

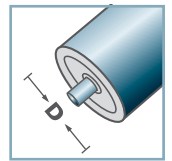

D [mm]

-

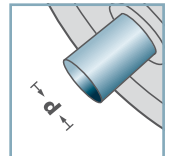

d [mm]

-



C [daN]

-

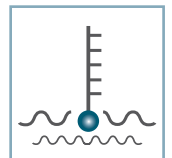

T [°C]

0° - 80°



-



Karton [Stck.]

100

Kunststoffzahnriemenrad

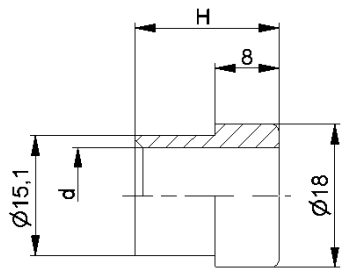

KKR-40		
Typ	d	H
KKR-40	10	19
KKR-40	12	18
KKR-40	14	19
KKR-40	SW11	19

Weitere Varianten auf Anfrage!

☛ Reduzierbuchse: Kunststoff

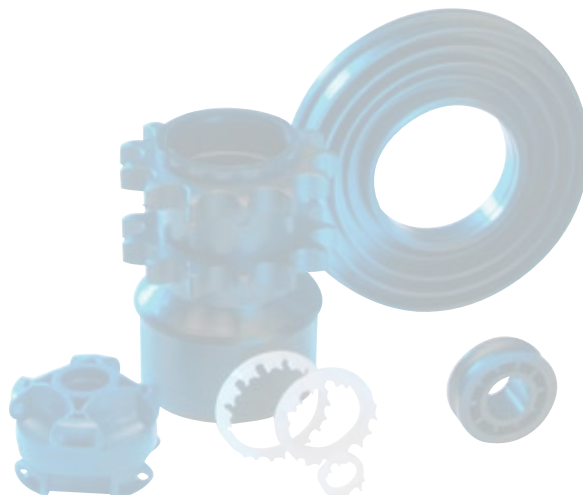

KKR-40

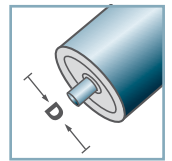

D [mm]

-

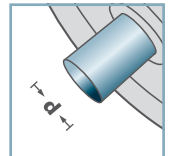

d [mm]

10; 12; 14; SW11



C [daN]

-

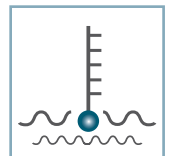

T [°C]

0° - 80°



-



Karton [Stck.]

1000

Zubehör Kettenräder

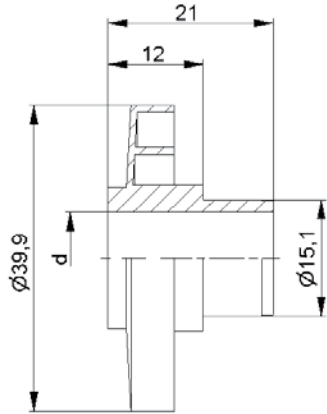

KKR-40	
Typ	d
KKR-40	10
KKR-40	12
KKR-40	14
KKR-40	SW11

Weitere Varianten auf Anfrage!

Labyrinth: Kunststoff

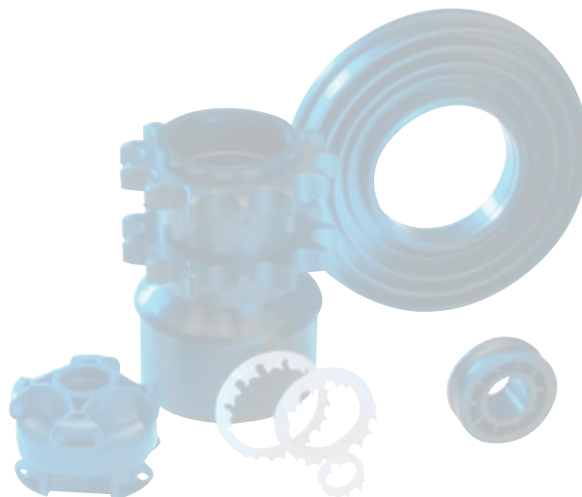

KKR-40

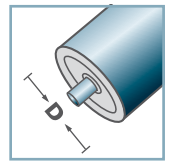

D [mm]

-

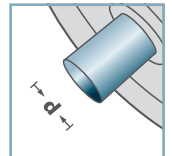

d [mm]

10; 12; 14; SW11



C [daN]

-

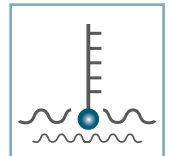

T [°C]

0° - 80°



-



Karton [Stck.]

200

Zubehör Kettenräder

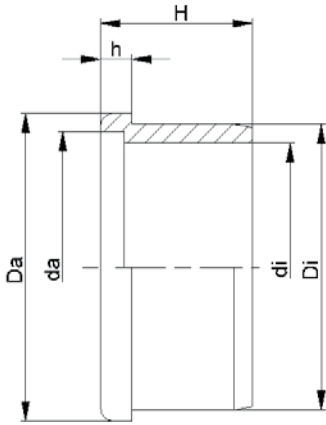

KKR-40

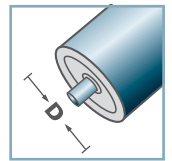

D [mm]
50 - 60

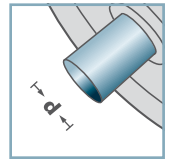

d [mm]
-



C [daN]
-

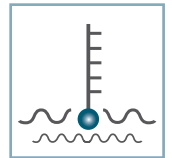

T [°C]
0° - 80°



-



Karton [Stck.]

400

KKR-40						
Typ	Di	Da	di	da	H	h
50x1,5	47,25	50	39,3	42,6	25,2	5
50x2,8	44,7	50	39,3	42,6	25,2	5
60x1,5	57,3	60	47,0	50,7	25,5	5
60x2,0	56,3	60	47,0	50,7	25,5	5

Weitere Varianten auf Anfrage!

C Distanzring fest: Kunststoff

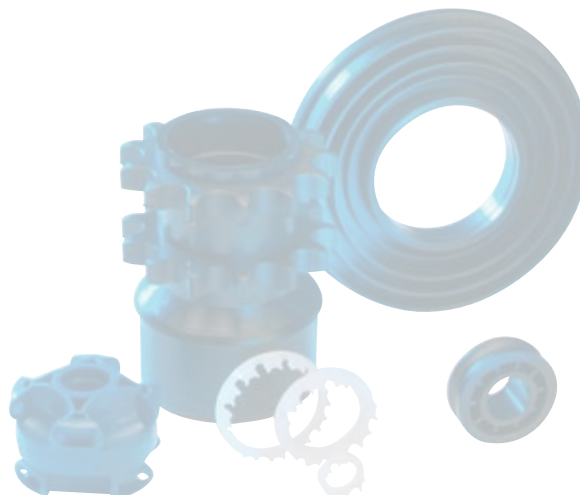

Zubehör Kettenräder

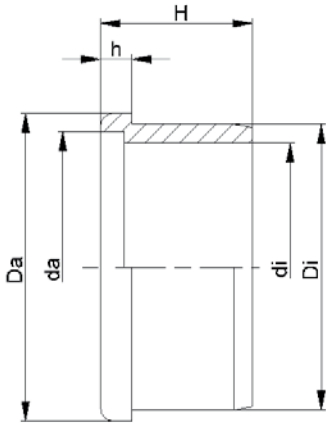

KKR-40						
Typ	Di	Da	di	da	H	h
50x1,5	47,2	50	40,6	44,6	25	5
50x2,8	44,6	49,7	40,6	44,6	25	4,8

Weitere Varianten auf Anfrage!

☛ Distanzring für Staubetrieb: Kunststoff

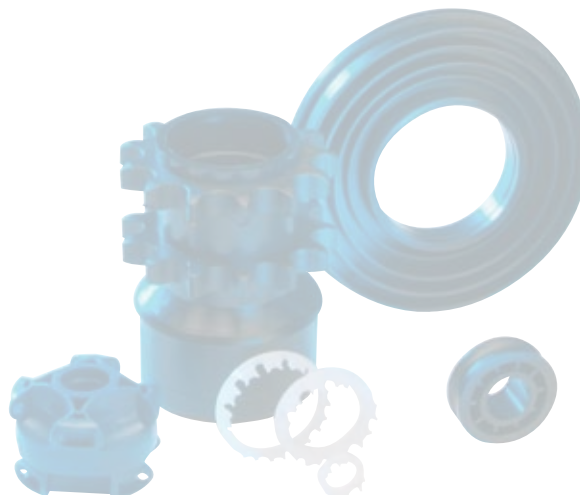

KKR-40

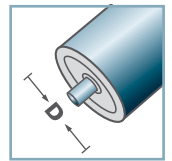

D [mm]
50 - 60

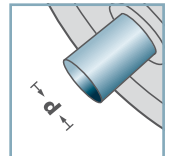

d [mm]
-



C [daN]
-

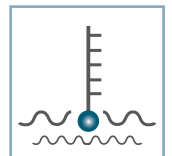

T [°C]
0° - 80°



-



Karton [Stck.]

400

Zubehör Kettenräder

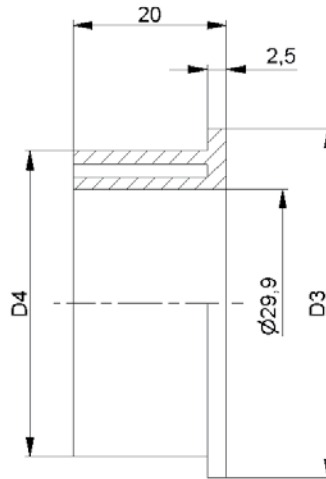
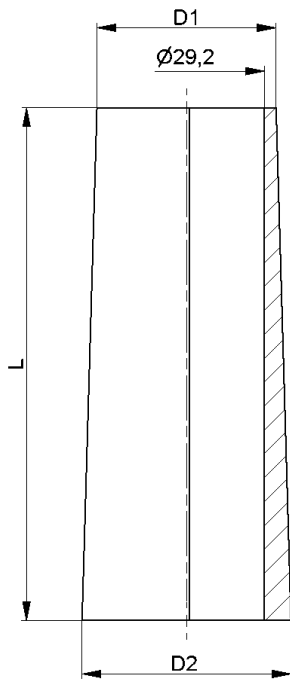

KF-30

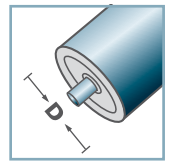

D [mm]
30

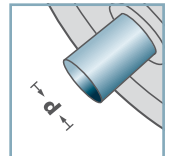

d [mm]
-



C [daN]
-

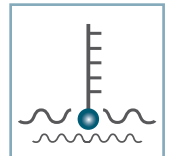

T [°C]
0° - 80°



-



Karton [Stck.]

KF-30					
Typ A	D1	D2	L	D3	D4
KF-30 I	33,6	39,2	96,4	-	-
KF-30 II	39,1	45,6	100,5	45,6	40
KF-30 III	45,7	52,1	100,5	52,1	46,7
KF-30 IV	52,2	58,8	100,5	57,9	57,9
KF-30 V	58,6	65,1	100,5	64,9	60,0
KF-30 VI	65,2	71,9	100,5	71,3	66,4

Weitere Varianten auf Anfrage!

- ☛ Konische Förderelemente: Kunststoff
- ☛ Enddeckel: Kunststoff

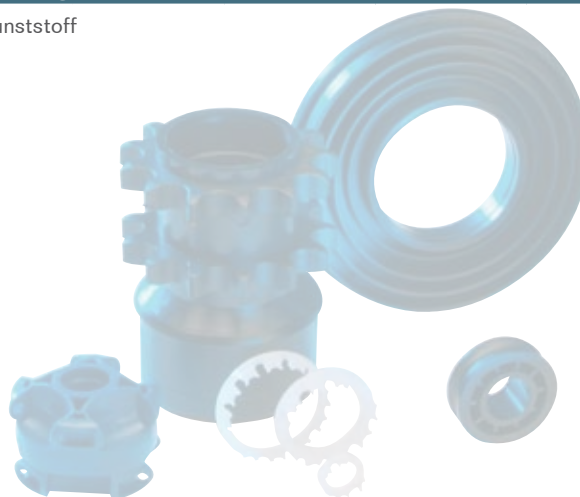

Konische Elemente

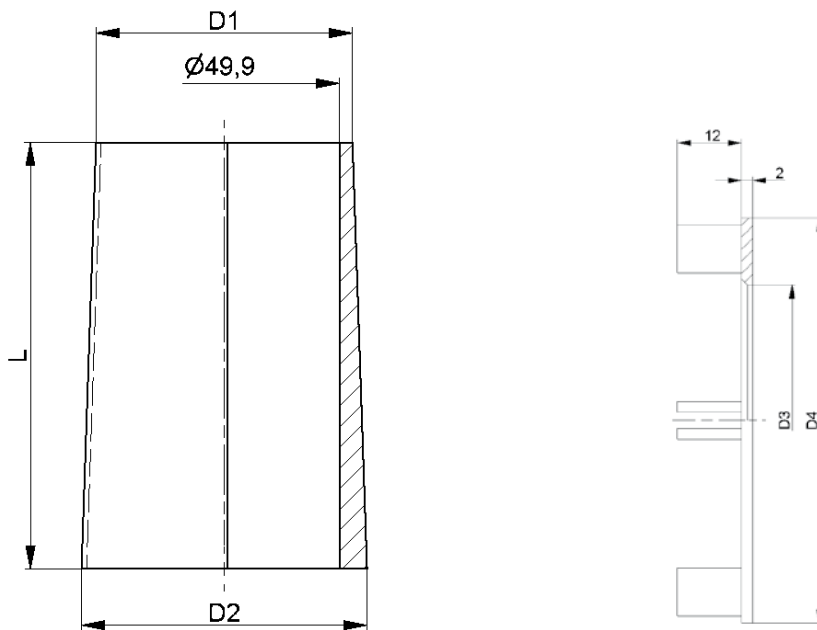

KF-50					
Typ A	D1	D2	L	D3	D4
KF-50 I-a	53,4	59,7	92,5	-	-
KF-50 I-b	54,0	59,7	95,5	-	-
KF-50 II	60,0	66,5	100,0	-	-
KF-50 III	66,5	73,0	99,0	-	-
KF-50 IV	73,5	80,0	100,0	50,6	75,5
KF-50 V	80,0	86,5	95,5	50,7	81,7
KF-50 VI	86,5	93,5	100,0	50,6	87,7
KF-50 VII	93,5	100,0	100,0	50,6	94,3
KF-50 VIII	100,0	106,5	95,5	-	-
KF-50 IX	106,5	113,0	95,5	-	-
KF-50 X	113,0	119,5	95,5	-	-

Weitere Varianten auf Anfrage!

- ☛ Konische Förderelemente: Kunststoff
- ☛ Enddeckel: Kunststoff

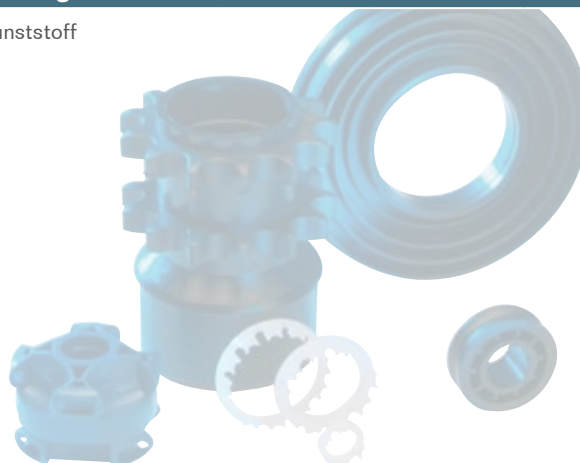

KF-50

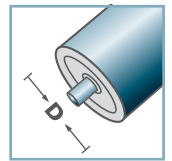

D [mm]
50

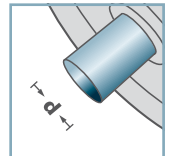

d [mm]
-



C [daN]
-

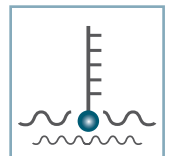

T [°C]
0° - 80°



-



Karton [Stck.]



Konische Elemente

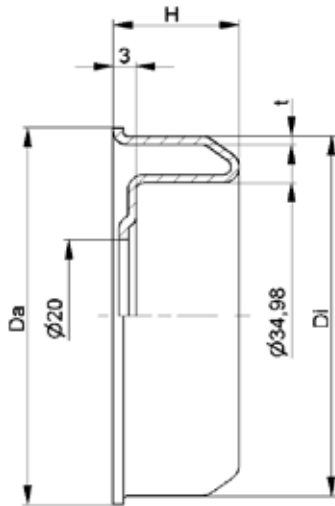

MRK-40

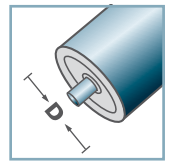

D [mm]
50 - 60

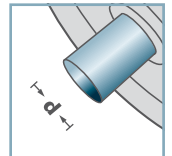

d [mm]
15



C [daN]
-

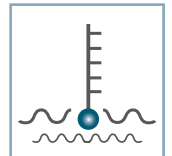

T [°C]
-



6202:
D35; d15; H11



Karton [Stck.]
ø50: 100
ø60: 250

MRK-40				
Typ	Di ±0,1	Da	H	t
MRK-50x1,5.40	47,3	49,5	16	1,2
MRK-50x2,0.40	46,3	49,5	16	1,2
MRK-60x2,0.40	56,3	59,5	16,5	1,5
MRK-60x3,0.40	54,3	59,5	16,5	1,5

Weitere Varianten auf Anfrage!

☛ Radkörper: Stahl, verzinkt

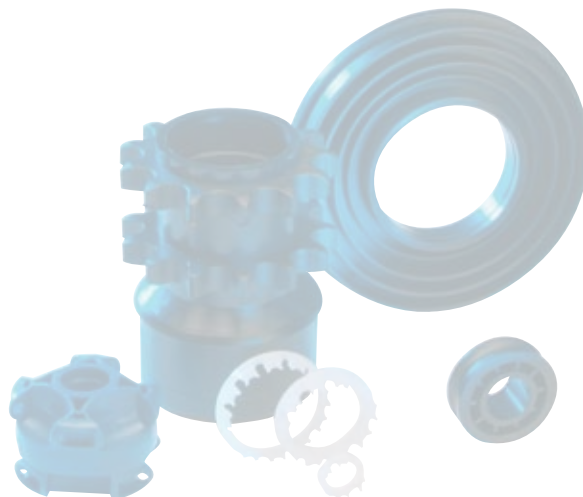

Metalradkörper

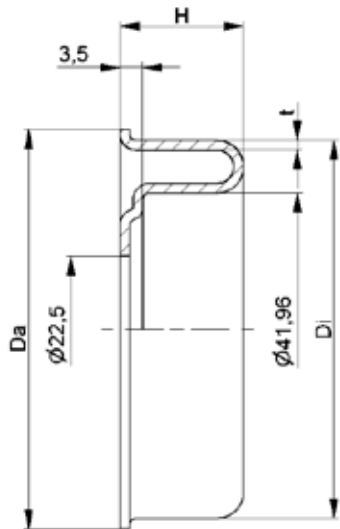

MRK-6004

Typ	Di ±0,1	Da	H	t
MRK-63,5x2,9/6004	58,1	61,5	19,0	1,5

Weitere Varianten auf Anfrage!

☛ Radkörper: Stahl, verzinkt

MRK-6004

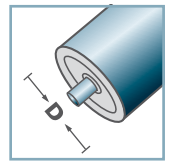

D [mm]
63,5

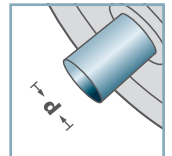

d [mm]
20



C [daN]
-

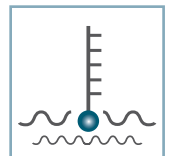

T [°C]
-



6004:
D42; d20; H12



Karton [Stck.]

50



Metalradkörper

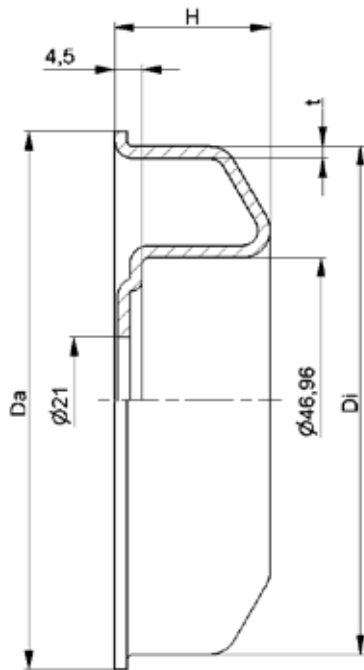

MRK-6204

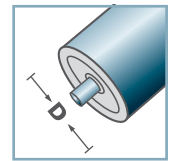

D [mm]
80 - 108

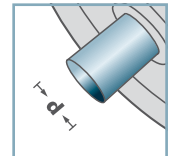

d [mm]
20



C [daN]
-

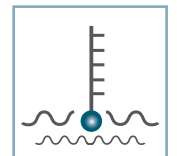

T [°C]
-



6204:
D47; d20; H14



Karton [Stck.]

50

MRK-6204				
Typ	Di ±0,1	Da	H	t
MRK-80x2,0/6204	76,5	79,5	23,5	2,0
MRK-80x3,0/6204	74,5	79,5	23,5	2,0
MRK-89x3,0/6204	83,5	88,5	23,5	2,0
MRK-89x3,25/6204	83,0	88,5	23,5	2,0
MRK-108x3,25/6204	102,0	107,5	25,0	2,0

Weitere Varianten auf Anfrage!

☛ Radkörper: Stahl, verzinkt

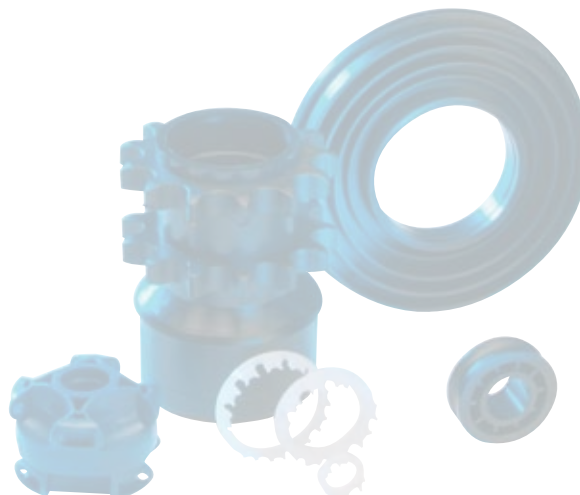

Metalradkörper

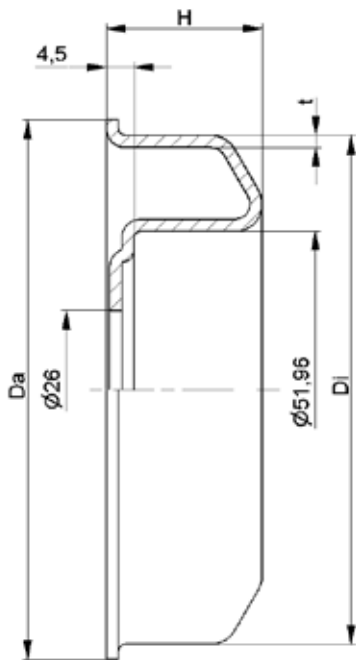

MRK-6205

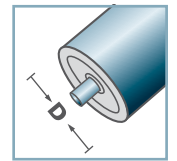

D [mm]
80 - 108

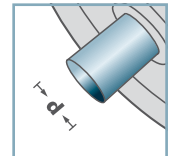

d [mm]
25



C [daN]
-

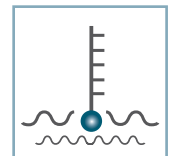

T [°C]
-



6205:
D52; d25; H15



Karton [Stck.]

50

MRK-6205				
Typ	Di ±0,1	Da	H	t
MRK-80x2,0/6205	76,5	79,5	23,5	2,0
MRK-80x3,0/6205	74,5	79,5	23,5	2,0
MRK-89x3,0/6205	83,5	88,5	24,5	2,0
MRK-108x3,25/6205	102,0	107,5	25,5	2,0

Weitere Varianten auf Anfrage!

- Radkörper: Stahl, verzinkt

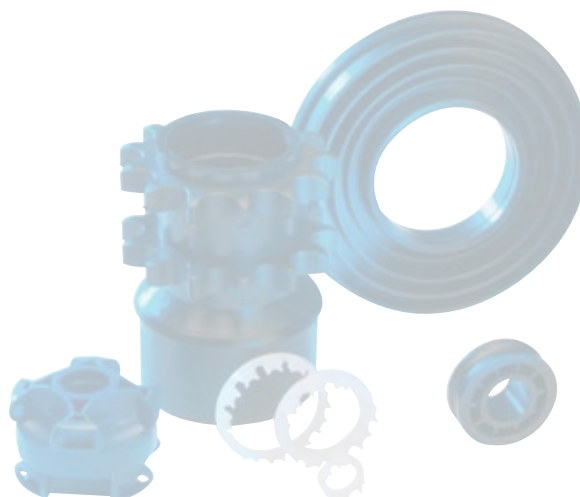

Metalradkörper