

MTR-01			
Typ	Di	Da	Tragzahl C [daN]
MTR-12x1,0.01	10,15	11,9	4

Weitere Varianten auf Anfrage!

- ☛ Radkörper: Niro
- ☛ Nabe: Niro
- ☛ Kugel: Niro



MTR-01

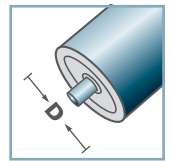

D [mm]
12

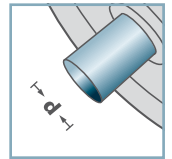

d [mm]
4



C [daN]
4

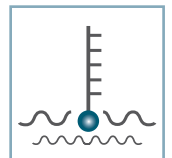

T [°C]
0° - 100°



Karton [Stck.]

MTR

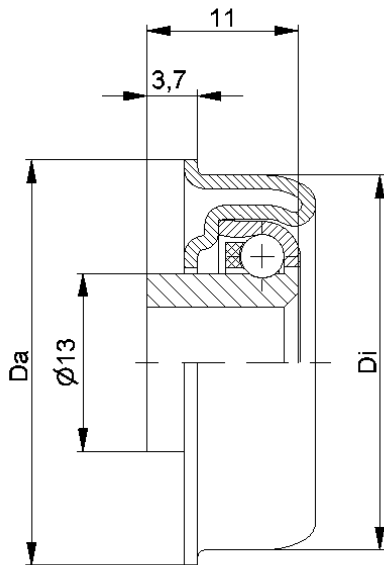

MTR-16

Typ	Di ±0.1	Da ±0.2	Tragzahl C [daN]
MTR-30x1,2.16	27,6	29,6	30
MTR-30x1,5.16	27,3	29,6	30

Weitere Varianten auf Anfrage!

- ☛ Radkörper: Stahl, verzinkt
- ☛ Kugellager RL-16
 - ☛ Lagerschale: Stahl, gehärtet
 - ☛ Innenring: Stahl, gehärtet, verzinkt
 - ☛ Kugelkäfig: Kunststoff
 - ☛ Kugel: Stahl



MTR-16

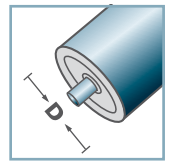

D [mm]
30

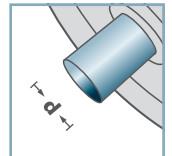

d [mm]
8; 10



C [daN]
30

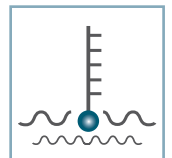

T [°C]
0° - 100°



Vactra No. 2



Karton [Stck.]

500

MTR

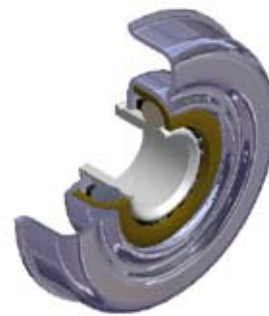
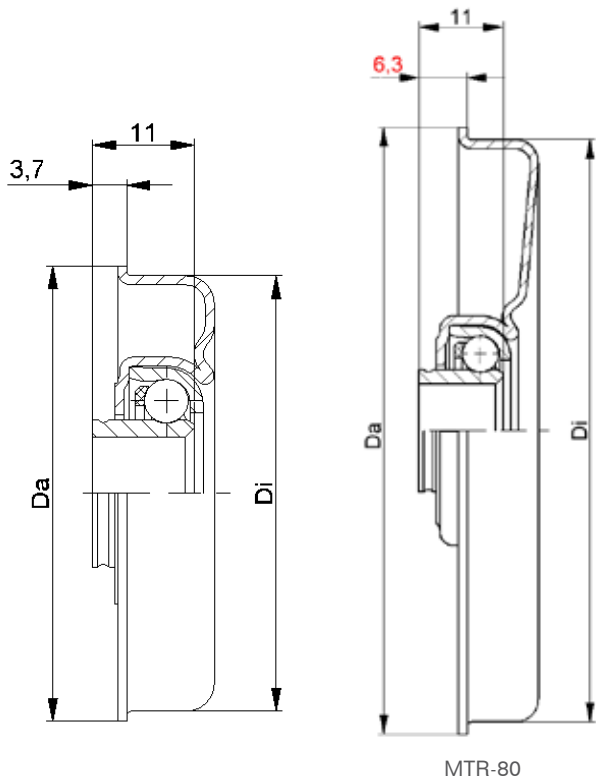

MTR-20

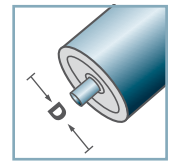

D [mm]
40 - 80

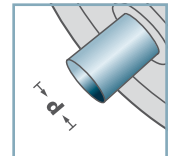

d [mm]
8; 10; 12; SW11

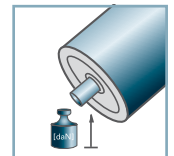

C [daN]
80

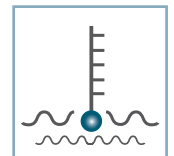

T [°C]
0° - 100°



Vactra No. 2



Karton [Stck.]

ø40:	250
ø48:	350
ø50:	350
ø60:	200
ø80:	125

MTR-20			
Typ	Di ±0.1	Da ±0.2	Tragzahl C [daN]
MTR-40x1,5.20	37,3	39,5	80
MTR-40x2,0.20	36,3	39,5	80
MTR-48x1,5.20	45,3	47,5	80
MTR-50x1,5.20	47,3	49,5	80
MTR-50x2,0.20	46,3	49,5	80
MTR-60x1,5.20	57,3	59,5	80
MTR-60x2,0.20	56,3	59,5	80
MTR-80x2,0.20	76,4	79,5	80

Weitere Varianten auf Anfrage!

- ☛ Radkörper: Stahl, verzinkt
- ☛ Kugellager RL-20
 - ☛ Lagerschale: Stahl, gehärtet
 - ☛ Innenring: Stahl, gehärtet, verzinkt
 - ☛ Kugelkäfig: Kunststoff
 - ☛ Kugel: Stahl



MTR

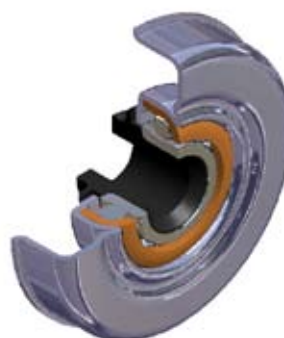
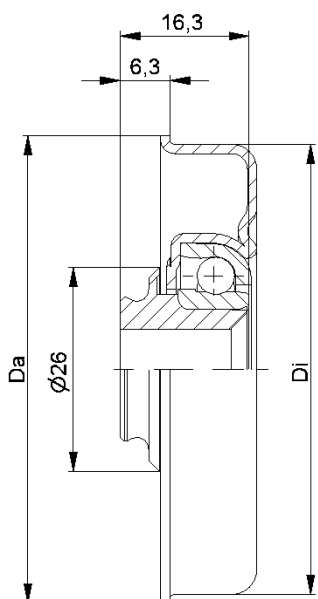

MTR-30

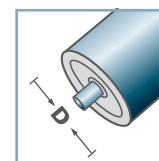

D [mm]
50 - 80

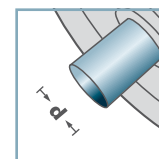

d [mm]
8; 10; 12; SW11

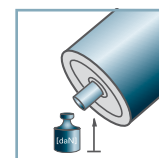

C [daN]
120

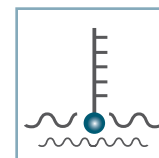

T [°C]
0° - 100°



EP 0



Karton [Stck.]

ø50: 300
ø60: 200
ø80: 125

MTR-30			
Typ	Di ±0.1	Da ±0.2	Tragzahl C [daN]
MTR-50x1,5.30	47,3	49,5	120
MTR-50x2,0.30	46,3	49,5	120
MTR-50x3,0.30	44,3	49,5	120
MTR-60x1,5.30	57,3	59,5	120
MTR-60x2,0.30	56,3	59,5	120
MTR-80x2,0.30	76,4	79,5	120

Weitere Varianten auf Anfrage!

- ☛ Radkörper: Stahl, verzinkt
- ☛ Reduzierbuchse: Kunststoff
- ☛ Kugellager RL-30
 - ☛ Lagerschale: Stahl, gehärtet
 - ☛ Innenring: Stahl, gehärtet
 - ☛ Kugel: Stahl



MTR

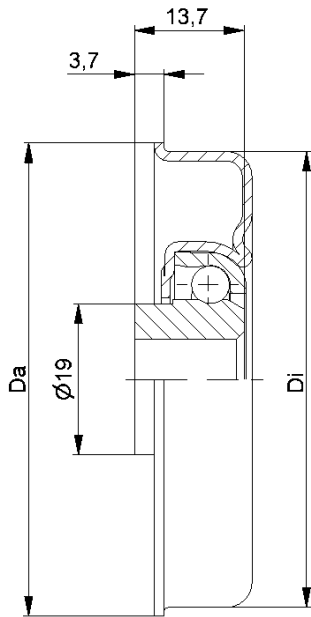

MTR-30-2

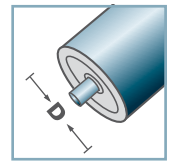

D [mm]
50 - 80

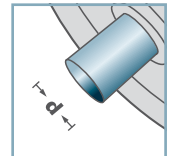

d [mm]
12; 14; 15; SW11



C [daN]
120

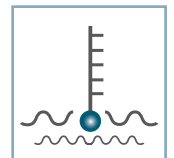

T [°C]
0° - 100°



EP 0



Karton [Stck.]
ø50: 300
ø60: 200
ø80: 125

MTR-30-2			
Typ	Di ±0.1	Da ±0.2	Tragzahl C [daN]
MTR-50x1,5.30-2	47,3	49,5	120
MTR-50x2,0.30-2	46,3	49,5	120
MTR-60x1,5.30-2	57,3	59,5	120
MTR-60x2,0.30-2	56,3	59,5	120
MTR-80x2,0.30-2	76,4	79,5	120

Weitere Varianten auf Anfrage!

- ☛ Radkörper: Stahl, verzinkt
- ☛ Kugellager RL-30-2
 - ☛ Lagerschale: Stahl, gehärtet
 - ☛ Innenring: Stahl, gehärtet
 - ☛ Kugel: Stahl



MTR

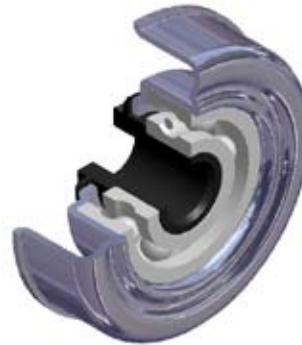
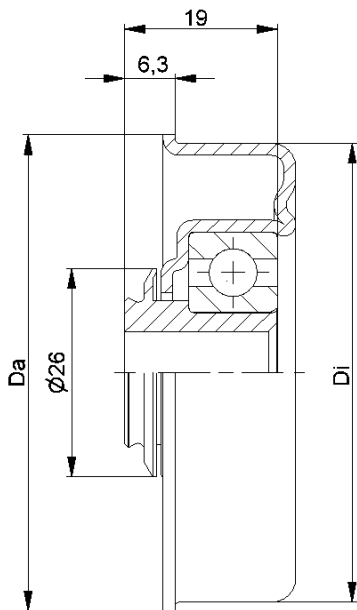

MTR-40

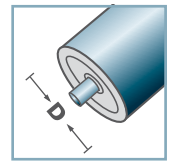

D [mm]
50 - 80

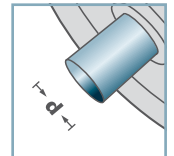

d [mm]
10; 12; SW11



C [daN]
120 - 150

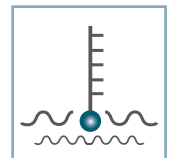

T [°C]
0° - 80°



EP 2



Karton [Stck.]

ø50: 100
ø60: 200
ø80: 125

MTR-40

Typ	Di ±0.1	Da ±0.2	Tragzahl C [daN]
MTR-50x1,5.40	47,3	49,5	120
MTR-50x2,0.40	46,3	49,5	120
MTR-60x1,5.40	57,3	59,5	150
MTR-60x2,0.40	56,3	59,5	150
MTR-60x3,0.40	54,3	59,5	150
MTR-80x2,0.40	76,5	79,5	150

Weitere Varianten auf Anfrage!

- ☛ Radkörper: Stahl, verzinkt
- ☛ Reduzierbuchse: Kunststoff
- ☛ Kugellager 6202



MTR

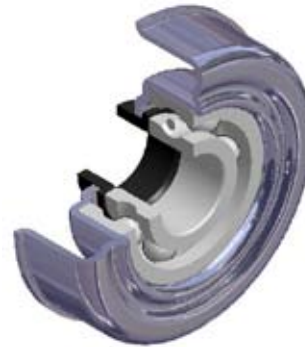
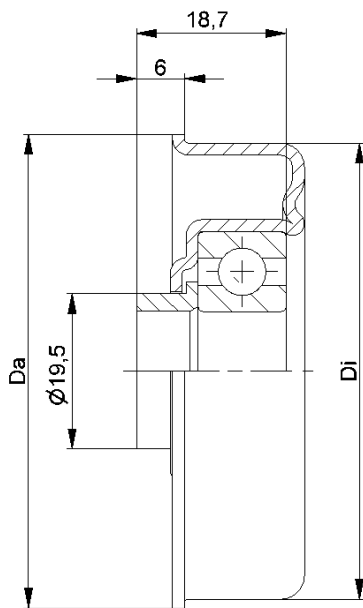

MTR-40.15

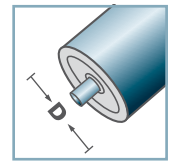

D [mm]
50 - 80

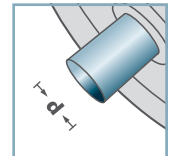

d [mm]
15



C [daN]
120 - 150

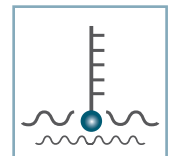

T [°C]
0° - 80°



EP 2



Karton [Stck.]

ø50: 100
ø60: 200
ø70: 125
ø80: 125

MTR-40.15			
Typ	Di ±0.1	Da ±0.2	Tragzahl C [daN]
MTR-50x1,5.40.15	47,3	49,5	120
MTR-50x2,0.40.15	46,3	49,5	120
MTR-60x1,5.40.15	57,3	59,5	150
MTR-60x2,0.40.15	56,3	59,5	150
MTR-60x3,0.40.15	54,3	59,5	150
MTR-70x2,0.40.15	66,4	69,5	150
MTR-80x2,0.40.15	76,5	79,5	150

Weitere Varianten auf Anfrage!

- ☛ Radkörper: Stahl, verzinkt
- ☛ Distanzbuchse: Kunststoff
- ☛ Kugellager 6202



MTR

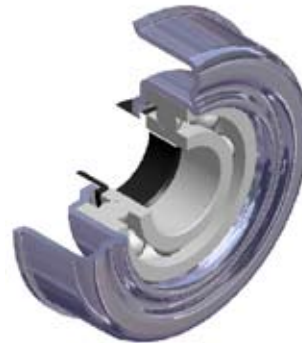
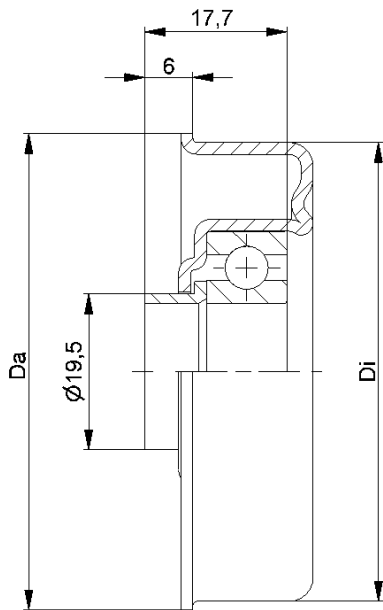

MTR-45.17

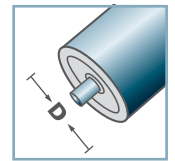

D [mm]
80

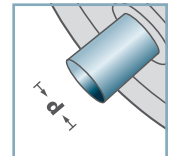

d [mm]
17



C [daN]
150

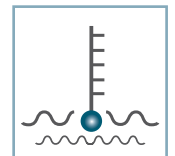

T [°C]
0° - 80°



EP 2



Karton [Stck.]
ø50: 100
ø80: 125

MTR-45.17			
Typ	Di ±0.1	Da ±0.2	Tragzahl C [daN]
MTR-50x1,5.45.17	47,3	49,5	120
MTR-80x2,0.45.17	76,5	79,5	150

Weitere Varianten auf Anfrage!

- ☛ Radkörper: Stahl, verzinkt
- ☛ Distanzbuchse: Kunststoff
- ☛ Kugellager 6003



MTR

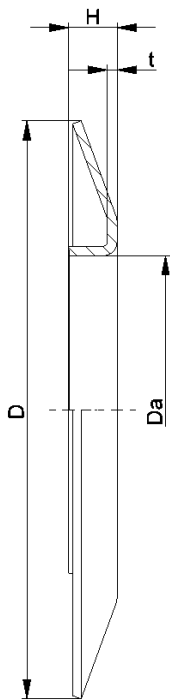

BS-

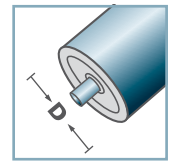

D [mm]
50 - 108

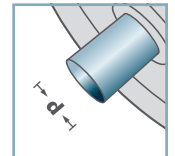

d [mm]
-



C [daN]
-

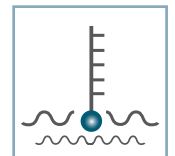

T [°C]
-



-



Karton [Stck.]

25

BS-				
Typ	Da ±0.1	D -2	H ±0.5	t
BS-50-130	49,9	130	10	1,5
BS-60-130	59,9	130	10	1,5
BS-80-150	79,9	150	14	2,5
BS-89-150	88,9	150	14	2,5
BS-108-150	107,9	150	14	2,5

Weitere Varianten auf Anfrage!

C Bordscheibe: Stahl



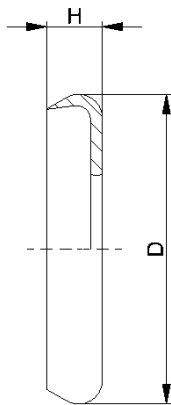

DK-MTR		
Typ	D	H
DK-MTR-20	34	7
DK-MTR-30-2	39	7

Weitere Varianten auf Anfrage!

☛ Dichtkappe: Kunststoff



DK-MTR-

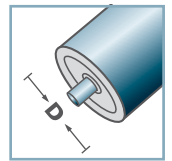

D [mm]

-

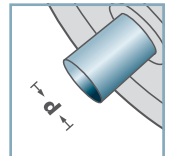

d [mm]

-



C [daN]

-

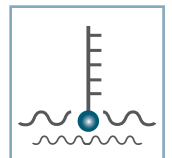

T [°C]

0° - 80°



-



Karton [Stck.]



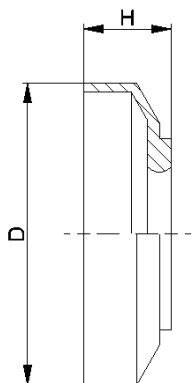

DK-MTR		
Typ	D	H
DK-MTR-30	38	11

Weitere Varianten auf Anfrage!

Dichtkappe: Kunststoff



DK-MTR-

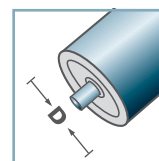

D [mm]

-

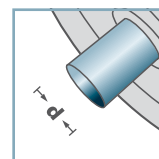

d [mm]

-

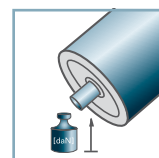

C [daN]

-

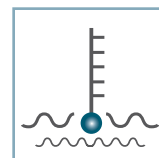

T [°C]

0° - 80°



-



Karton [Stck.]

